

## 10 Watt Amorphous Solar Module

### EVERLIGHT ELM-10A

#### FEATURES:

Best Electric Performance in Weak Light, Under weak light conditions, parameters of a-Si solar changing current and Voc are stable, c-Si solar cell's Voc is only half of a-Si solar cell.

Best Power Generation Capacity, Amorphous silicon solar (a-Si) cell has the best weak light performance with comparing to the same power c-Si solar cell, more power generation capacity about 10%~20%.

Especially in rainy areas, the power will be accumulated whole years by a-Si solar cells than mono-crystal silicon and poly-crystal silicon.

It is permanently sealed and protected against the environment and thermal stress.

#### APPLICATIONS:

- Automatized controls
- Electric powers
- Information and communications
- Lightings
- Household electrical appliances
- Building –Integrated Photovoltaic (BIPV) for roofs and facades
- Other solar applications

Typical Electrical Characteristics	
Maximum power	10W
Voltage at max. power	21V
Current at max. power	0.48A
Open circuit voltage	30V
Short circuit current	0.6A
Max. oper. voltage	1000V
Operating temperature	-40/+85 °C
Mechanical Characteristics	
Dimensions(mm)	625×325×25
Overall tolerances	±3mm
Weight(Kg)	3.0

Test conditions: @STC 1000W/m<sup>2</sup>, AM1.5, 25°C

#### WARRANTIES:

- Pm is not less than 90% in 10 years and 80% in 20 years
- 2 year product warranty

#### Module Diagram

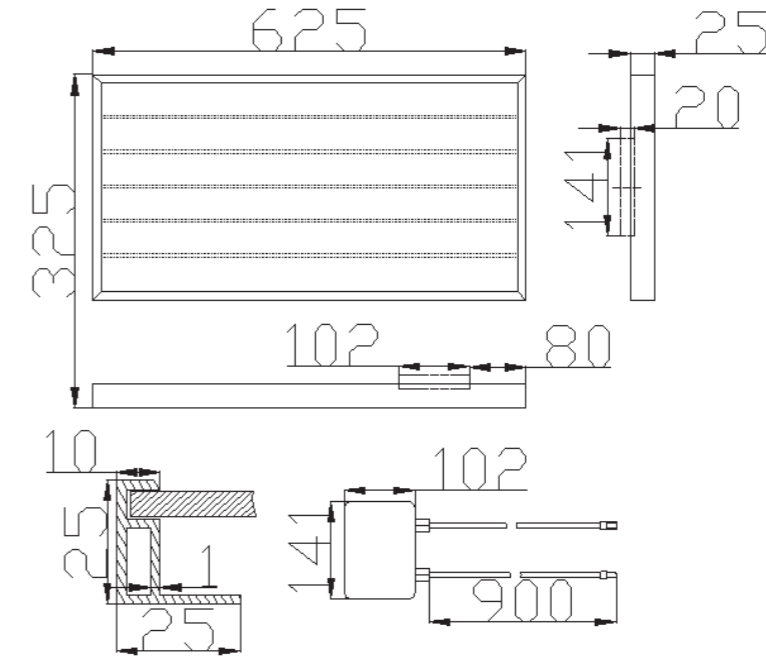

#### Graph

