



120 Watt Photovoltaic Module

EVERLIGHT ELM-120P Series

EVERLIGHT ELM-120P is designed specifically for on-grid residential systems where a combination of high module efficiency and outstanding appearance is desirable. Utilizing 36 cells (150 x 150mm) configured geometrically in a 9 x 4 matrix connected in series. An anti-reflective coating, provides a uniform blue color and increases the absorption of light in all weather conditions. Designed to withstand rigorous wither conditions; the multifunctional junction box avoids from eroding by moisture or humidity; torsion -proof, anodized and corrosion -free aluminum frame tightened by inner corner without using any screws, making EVERLIGHT ELM-120P great appearance and less power decrease during warrant period.

TYPICAL ELECTRICAL CHARACTERISTICS			
	ELM-120P-1	ELM-120P-2	ELM-120P-3
Maximum power	110W	120W	130W
Voltage at max. power	17.2 V	17.2 V	17.2 V
Current at max. power	6.40A	6.98A	7.56A
Open circuit voltage	21.7V	21.7V	21.7V
Short circuit current	7.24A	7.90A	8.56A
Temperature coefficient of Isc	(0.065±0.015)%/°C		
Temperature coefficient of Voc	-(160±20)mV/°C		
Temperature coefficient of power	-(0.5±0.05)%/°C		
Max. oper. voltage	1000V		
Operating temperature	-40/+85 °C		
Resistance	227g steel ball down from 1m height and 60m/s wind		

PERFORMANCE			
Model	ELM-120P-1	ELM-120P-2	ELM-120P-3
Rated power	110W	120W	130W
Tolerance	±5%	±5%	±5%
Module efficiency	13.6%	13.6%	16.1%
Nominal voltage	12V	12V	12V
Warranty	Pm is not less than 90% in 10 years and 80% in 25 years		

MECHANICAL CHARACTERISTICS	
Dimensions(mm)	1425×650×40
Overall tolerances	±3mm
Weight(Kg)	10.8
Frame	Clear anodized aluminum alloy type 6063T6. Silver Universal frame.
Solar Cells	36 cells (150 x 150mm) configured geometrically in a 9 x 4 matrix connected in series.

Test conditions: @STC 1000W/m², AM1.5, 25°C

Product Standards: CE certified, TÜV according to IEC 61215 expected by Oct. 2007.

Module Diagram

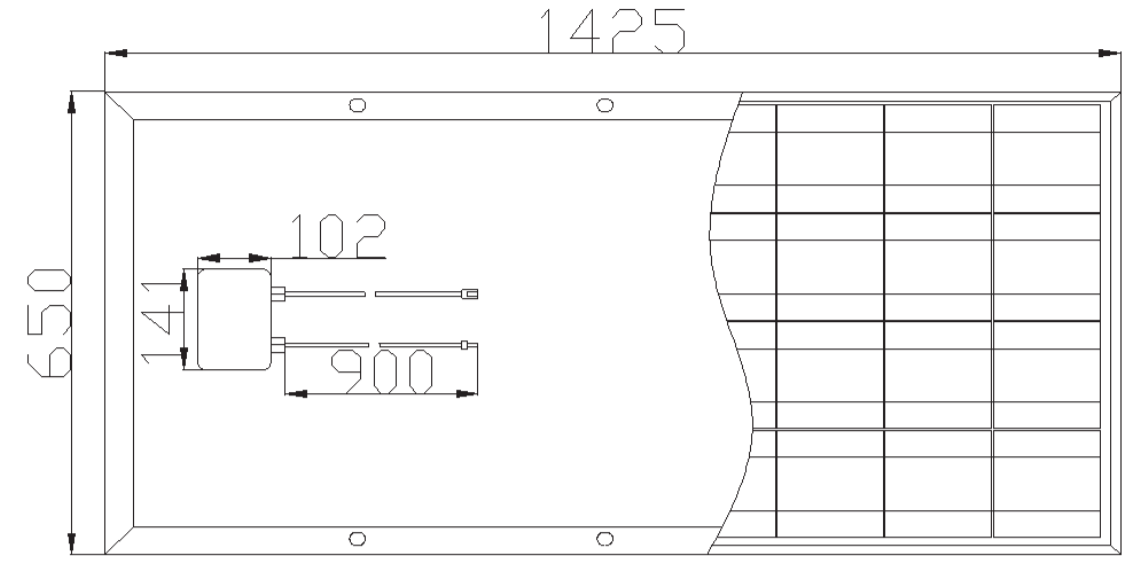

Graph

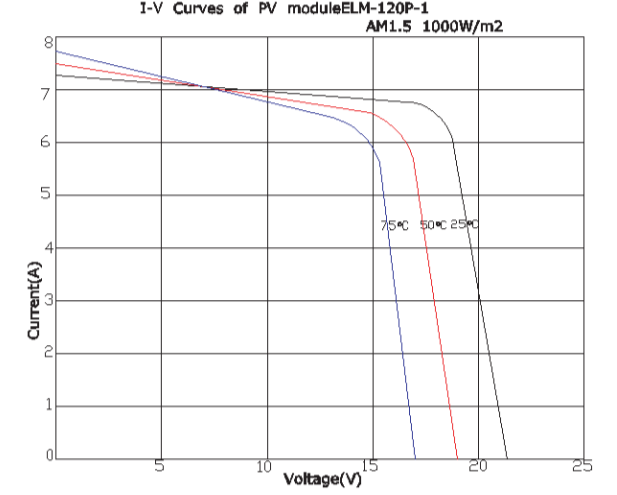
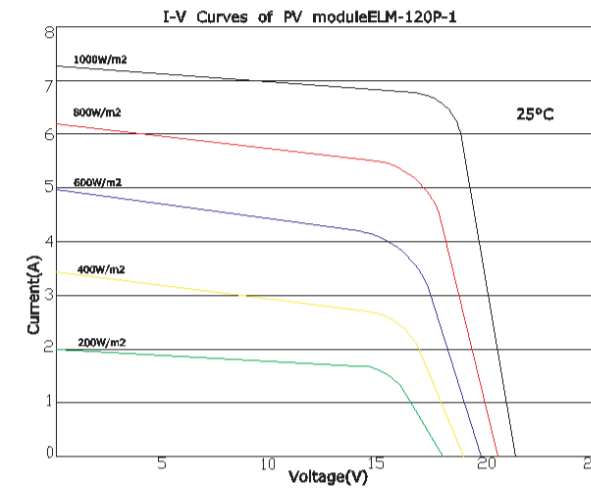

www.everlight-solar.com

www.everlight-solar.com

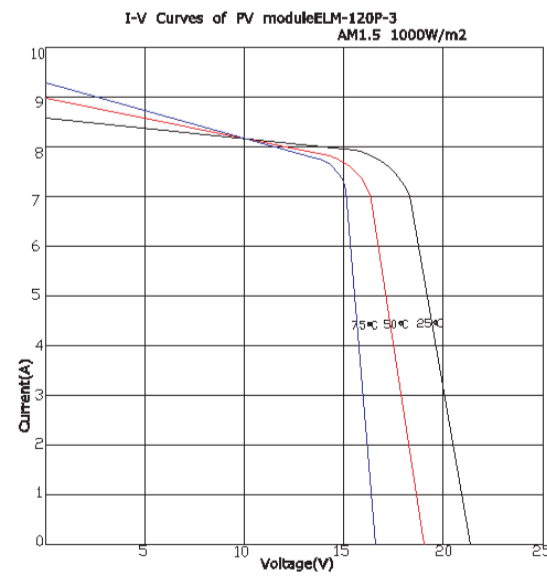
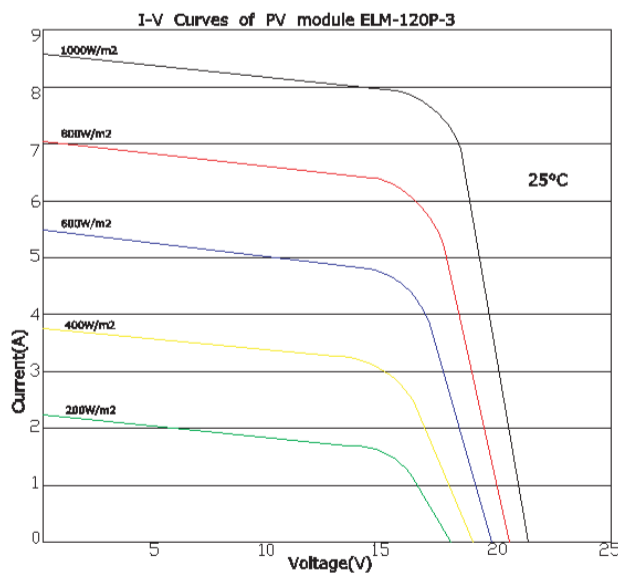
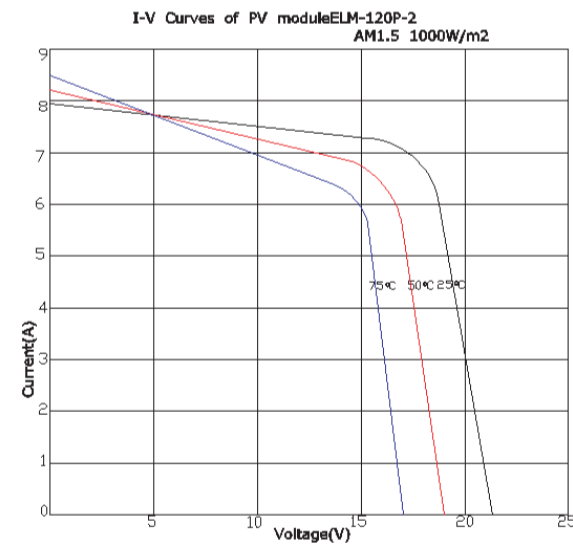
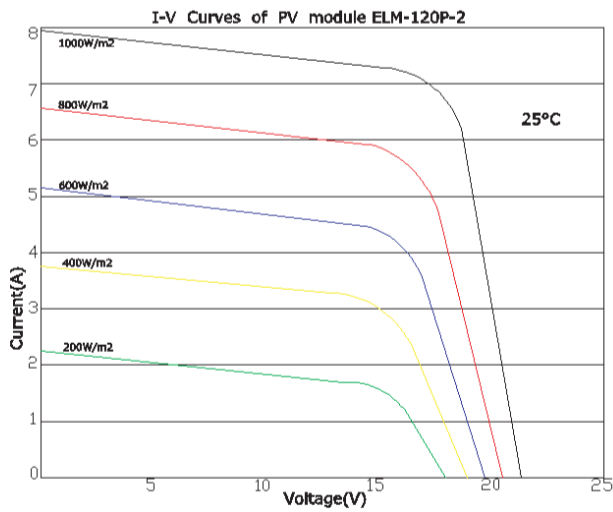

www.everlight-solar.com

www.everlight-solar.com